

RCF | FORUM SYSTEM | CONFERENCING SOLUTIONS



EVERY TIME WE DESIGN AN AUDIO COMPONENT OR SYSTEM, HOWEVER SIMPLE OR COMPLEX IT MAY BE, WE HAVE TO KEEP THE NEEDS OF INSTALLERS AND USERS AT THE FOREFRONT OF OUR MINDS. WE CAN COUNT ON THE EXPERIENCE AND TECHNOLOGIES DEVELOPED OVER MORE THAN 50 YEARS ACTIVITY IN THE AUDIO SECTOR TO CREATE SAFE, RELIABLE AND COMPETITIVE PRODUCTS THAT ALWAYS STAND OUT FOR THEIR HIGH LEVEL OF ADDED VALUE.

EVERY RCF CONFERENCE SYSTEM IN THIS CATALOGUE IS DESIGNED WITH THE SAME PHILOSOPHY TO OFFER SOPHISTICATED STATE OF THE ART TECHNOLOGY, SIMPLE INSTALLATION AND CONFIGURATION, BUT MORE IMPORTANTLY A USER-FRIENDLY INTERFACE FOR THE CUSTOMER.

RCF | FORUM SYSTEM | CONFERENCING SOLUTIONS

The RCF Forum 9000 includes fully digital, audio and data management system and was designed for applications including the management of local, provincial, regional and government-level authority conventions, meetings of boards of directors, council chambers, congress halls and parliament. It includes many customisable solutions for conferencing and voting that can be configured and PC-controlled. Forum 9000 is designed to be fully integrated with simultaneous interpretation system RCF Forum 2000. The system can be implemented with cameras for automatic filming of delegates, with digital audio recording and intervention archiving applications. Forum 9000 can be installed using simple widely available "Cat 5" cables and RJ45 connectors.

The RCF Forum 6000 system offers all the performance features required of conferencing and debating systems, including operative functions and modes that are usually available only in more complex products. The main applications include: meetings, small council chambers, congress halls, conference rooms and auditoria. It can also be used for more "mobile" purposes, such as temporary events or halls where the system needs to be uninstalled after use. Forum 6000 also includes an integrated simultaneous translation system for foreign language guests. The system offers a wide range of options including the automatic management of a speaker booking queue and, with an accessory, the control of the cameras and a functional PC interface to enable/disable microphone consoles from a synoptic panel. The 6000 System is easily assembled using RJ45 type connectors.

RCF Forum 2000 is an innovative UHF digital wireless solution for simultaneous interpretation, able to solve the main issue usually faced with the traditional infrared transmission approach. In fact, through a couple of small antennas connected to the digital transmitter, the system can cover a room even several thousands square meters large. The safety and the privacy are set at the highest level thanks to an exclusive double encrypting code developed according to MIL standard criteria; the user can simply create new codes as well, even a different one for each event. Forum 2000 is, as all RCF Forum products, simply to install and easy to use.

As with all RCF products, the support and service offered by our technical sales and support network, which has a global capillary coverage, is able to guide and advise customers and users in the choice, installation and customised configuration of the system.



CONFERENCE SYSTEM

FORUM 9000



THE IDEAL SOLUTION FOR:

COUNCIL CHAMBERS
(CITY, COUNTY, REGIONAL
GOVERNMENT)

CONGRESS CENTRES

BOARD OF DIRECTORS MEETINGS
(BANKS, INSURANCE FIRMS, ETC.)

PARLIAMENTARY CHAMBERS



DIGITAL CONFERENCE AND VOTING MANAGEMENT SYSTEM

Forum 9000 is a totally digital conference system regulating participations with additional possibilities of voting, audio and video broadcasting, streaming and recording as well as simultaneous translation.

120 consoles FMS 9411-S on 4 lines can be connected to the main unit FMU 9100 and, thanks to the FPS 9600 additional power supply unit, the system is expandable up to 250 consoles.

The installation is extremely quick and easy by means of CAT5 UTP cables, without using boosters or splitters. Forum 9000 offers the possibility to assign various functions (chairman, secretary, delegate) in every moment to every microphone set without modifying the system hardware. Moreover, through the use of chip-cards inserted into the microphone set, the system can upload data, log in and check the presences during conference and voting.

It is also possible to transmit the video, the synoptic view and the voting results on a LCD, plasma or video projector.

Forum 9000 is designed according to IEC 60914 standard.

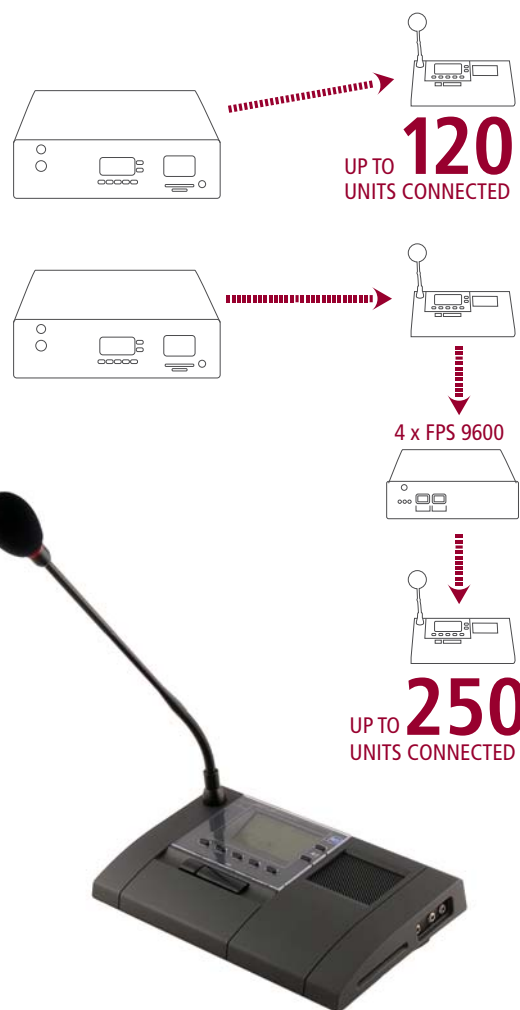

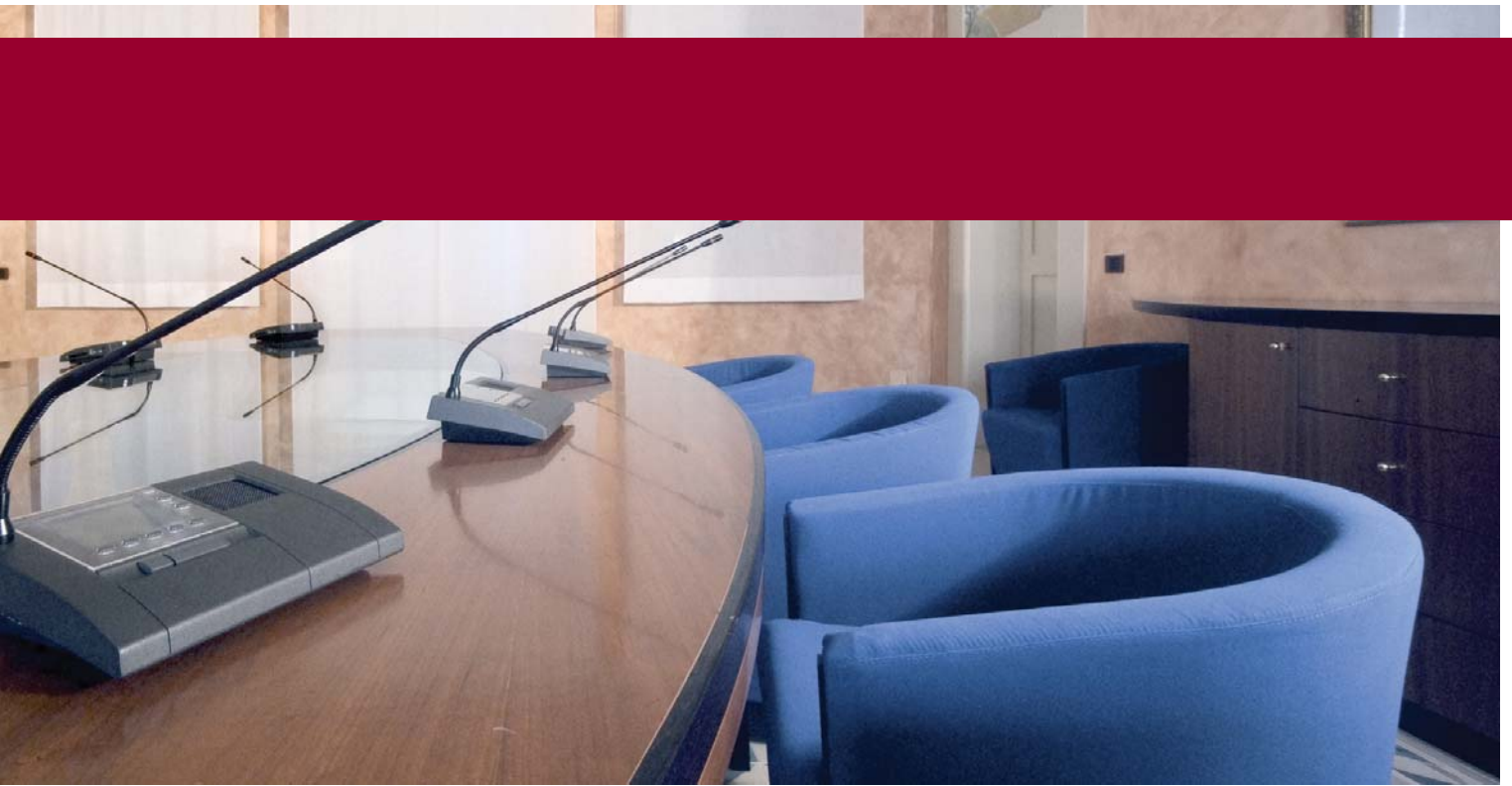

The system can operate in two ways:

- 1) Stand-alone: the main unit can manage basic functions;
- 2) Computer expanded: the system is managed by a PC Graphical User Interface that allows to use a lot of additional powerful functions.

Four different conference modes are possible:

- 1) Free discussion;
- 2) Automatic discussion;
- 3) Automatic Timed discussion;
- 4) Managed discussion from PC or from Chairman/Secretary console.

One of two voting modes can be selected:

- 1) Evident;
- 2) Confidential.

Voting management options are various and can be customized (as described later) as the visualization of data and operations. Additional tools are available, for example: the confirmation of the presence before voting, a progressive control of voting (different for evident and confidential voting), the assignment of different weight to votes and the quorum that can be expressed in a numerical way or in percentage.

FORUM 9000 | CENTRAL UNIT



CENTRAL UNIT FMU 9100

p/n. 171.80.001

The central unit allows to connect and manage digitally up to 120 consoles on four lines (30 each) by means of CAT5 UTP cable. Through the FPS 9600 additional power unit is possible to connect up to 250 microphone consoles. An audio reinforcement system can be connected through 4 LINE level outputs and turned off or attenuated with the insertion of groups of microphones; a recorder and a remote conference audio system can also be connected as well, as a personal computer through USB or RS232. Moreover, it has two inputs MIC/LINE that can be set by PC with priority or in mixing mode over the other consoles. It includes a Smartcard reader/writer in order to set up the features of every microphone set and to activate the available options. The main unit, operating in stand-alone mode, allows to use the system for a basic conference and voting thanks to its

graphical backlit display and the interactive push-buttons. It allows the monitoring of the conference by means of a loudspeaker monitor or from the 6,3 mm jack headphone output, available on the frontal panel. It allows to simply recall recorded presets corresponding to several configurations of different conference halls or to other uses of the same room, activating different numbers of microphone units, eventually assigning various features to the same one (Secretary, Chairman, Delegate), or again various operation modalities (e.g. free or timed conference, with or without Smartcard, with right or not of voting, a various number microphone units that can be turned on at the same time, etc.).

It allows the monitoring of the conference by means of a loudspeaker monitor or from the 6,3 mm jack headphone output, available on the front panel.

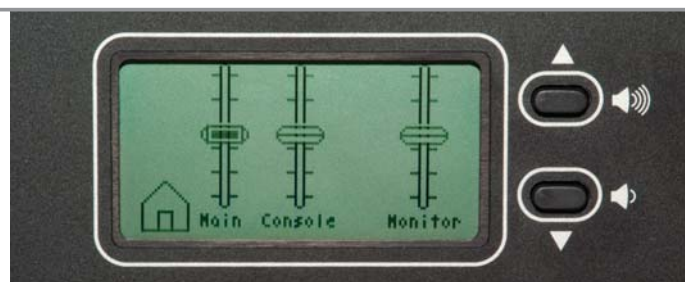

SPECIFICATIONS FMU 9100

SUPPLY VOLTAGE	AUTOMATIC 115 / 230 V □ 10%
POWER CONSUMPTION	MAX 350 W
FREQ. RESPONSE	70 Hz TO 15 kHz
CROSSTALK ATTENUATION	>90 dB
DYNAMIC RANGE	>90 dB
AUTOMATIC GAIN REDUCTION:	
2 ACTIVE MICROPHONES	3 dB
5 ACTIVE MICROPHONES	6 dB
WORKING CONDITIONS	FIXED/TRANSPORTABLE
TEMPERATURE RANGE	-20 □ +55□C (OPERATING -10 □ +50□C)
RELATIVE HUMIDITY	90%
DIMENSIONS	430 X 140 X 370 MM
WEIGHT	11.5 Kg
CONTROL	1 ON/OFF BUTTON WITH LED 1 BACK-LIT GRAPHIC DISPLAY 128X64 PIXEL 5 INTERACTIVE MULTI-FUNCTION KEYS 2 VOLUME KEYS
INPUT	2 MIC/LINE WITH VOX (CONFIGURABLE) 1 SMART CARD READER/RECORDER 1 GPI
OUTPUT	4 ADJUSTABLE LINE 1 TAPE OUT 1 AUDIO FOR REMOTE CONFERENCE
IN/OUT	4 CONSOLE LINES 1 USB 1 RS232 2 INTERPRETER CONSOLE LINES (UP TO 15 SIS 2411X PER LINE)
CONNECTIONS AND WIRES	RJ45 / CAT5 UTP



FORUM 9000 | MICROPHONE SET

■ MICROPHONE SET

FMS 9411-S p/n 171.80.028

FMS 9411-SL p/n 171.80.038

A unique microphone set is configurable as Delegate/Chairman/Secretary. Every microphone set, made in grey antracite zinc-aluminium die cast alloy (also suitable for semi flush mount installation), is equipped with a hypercardioid professional microphone with luminous ring on gooseneck indicating its activation. Every microphone set has a high efficiency, high quality neodymium loudspeaker which is automatically attenuated when the microphone or the neighbours ones are turned on, in order to reduce the acoustic feedback.

The signal of the microphone is not affected by mobile phones transmissions. Every console is provided with an headphone output, a LINE output and a microphone input to allow maximum operation comfort.

The user interface is intuitive and it is composed by a Smart-Card reader/writer, two multi-function talk push-buttons associated to LEDs, two buttons for adjusting the output volume of the local loudspeaker (or headphones) and 5 contextual keys assigned time to time to icons on the graphic display for conference and voting. The use of a Smart-Card is fully supported by the display that interacts with the user, providing useful information (wrong card, card to use on another microphone unit, etc).

The FMS 9411-SL presents all the features of the standard FMS 9411-S console but it is equipped with a 60 cm (23.62") gooseneck microphone to provide more comfort if the speaker stands up while talking.



FMS 9411-S



FMS 9411-SL

THE SAME MICROPHONE UNIT CAN ASSUME THE VALENCE OF DELEGATE, CHAIRMAN OR SECRETARY.

- **Delegate:** beyond the functions already mentioned, the microphone unit allows to activate and to deactivate the microphone, to insert the "mute" function, to reserve for speaking, to confirm the presence, to vote. Results of the voting, messages sent from PC, hour and date, residual speech time, position in the list of talkers will be also displayed.

- **Secretary:** it works as a delegate with the possibility to assign the management of the conference and/or

voting, but without the priority performance which is reserved to the Chairman only. Secretary set-up allows mixing mode activation.

- **Chairman:** beyond the functions already mentioned the microphone unit allows to set up the kind of conference and to manage its modality, to demand presences and to manage the voting, to recall the attention of the participants and to invite the Delegate to finish talking.

SPECIFICATIONS FMU 9411-S

MICROPHONE	PROFESSIONAL ELECTRET
DIRECTIVITY	HYPERCARDIOID
FREQ. RESPONSE	70 Hz □ 18 kHz
LOUDSPEAKER	1W, HIGH QUALITY, HIGH EFFICIENCY WITH NEO MAGNET
DISPLAY	GRAPHIC TYPE 128 X 64, BACK-LIT
LED STATUS	TALK / BOOK / MUTE / SPEAK-SLOWLY LED RING ON GOOSENECK MICROPHONE
CONTROL	2 VOLUME KEYS LOUDSPEAKER / HEADPHONE 2 TALK / BOOK / MUTE BUTTONS 5 CONTEXTUAL MULTI-FUNCTION KEYS
LANGUAGES	MULTIPLE LANGUAGES CAN BE DISPLAYED
IN/OUT CONNECTIONS	1 IN RJ45 1 IN MIC 1 OUT RJ45 1 OUT HEADPHONES 1 OUT LINE 1 SMART-CARD READER / WRITER
DIMENSIONS	240 X 60 X 150 MM
WEIGHT	1.7 Kg

NOTE: SEMI-FLUSH MOUNTING FACILITY.

■ ADDITIONAL POWER SUPPLY UNIT FPS 9600

p/n 171.80.028

The FPS 9600 power supply unit allows to connect up to 60 FMS 9411-S microphone consoles on each of the 4 FMU 9100 master unit outputs.

The FPS 9600 must be used on each line with more than 30 microphone consoles or on lines where the cable is longer than 130 metres.

- The connection of the FPS 9600 is made through cat 5e or 6 with RJ 45 connectors
- Main switch on the rear panel
- 3 LED indicators report the power supply status
- Power supplier is powered by AC Mains 115/230 W (auto-range)
- Power output on RJ 45 connector



FORUM 9000 | MANAGEMENT SOFTWARES



■ MANAGEMENT SOFTWARE FSW 9010 - C

p/n SW38001

The management system software is extremely simple to use and allows a wide range of functions and graphics customisation. The synoptic diagram of the hall can be freely shaped: it is possible to create a structure, to place microphone units in an interactive way, to assign several functions to each microphone unit, to associate name and features of the delegates (loadable data from PC or from smart card) to every console, to save an recall configurations.

All audio levels and configurations can be controlled. FSW 9010-C allows to set the conference and the details of the operating modes such as active channels (up to 5 at the same time), talking time, warning signals, reference times, the queue (it can be modified by the software manager). **This powerful software permits to fully handle the conference by PC, activating and deactivating consoles, muting the microphones and enabling the external microphones directly connected on the main unit AUX inputs.**

- Software windows can be customized
- Free updates will be sent via email
- Forum software can be controlled through touch screen computers

■ VOTING SOFTWARE FSW 9020 - V

(requires FSW9010-C)

p/n SW38002

The voting allows to manage different parameters: it permits to introduce a quorum to be reached, to enable/disable the voting, to demand for presence confirmation to establish the voting mode if evident or confidential, free or timed. It also allows to show, save and print the graphic of the voting results.

FSW 9020-V allows to manage an agenda in which the arguments of the session are indicated, with the possibility to memorize and to recall an unlimited number of topics, to edit, import and save the day running order as well as the voting type and results for every argument of the session. Furthermore it is possible to compile a session log, to record and print the participants list with any detail. It allows to display to the audience (through a screen or a projector) the main slides during the conference: synoptic diagram, reservations list, topics, talker generality and numeric results of the voting, using histograms or pie-diagrams.

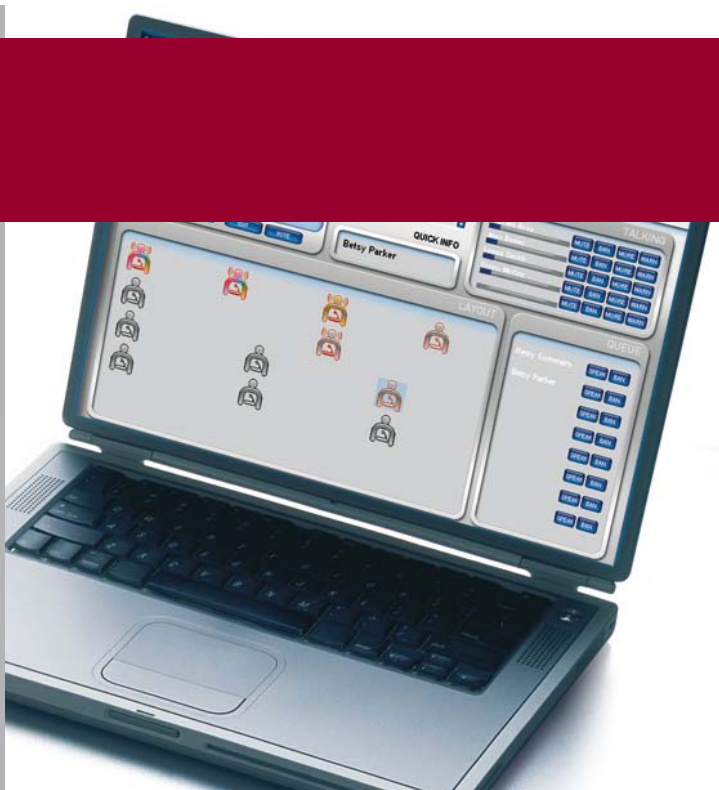
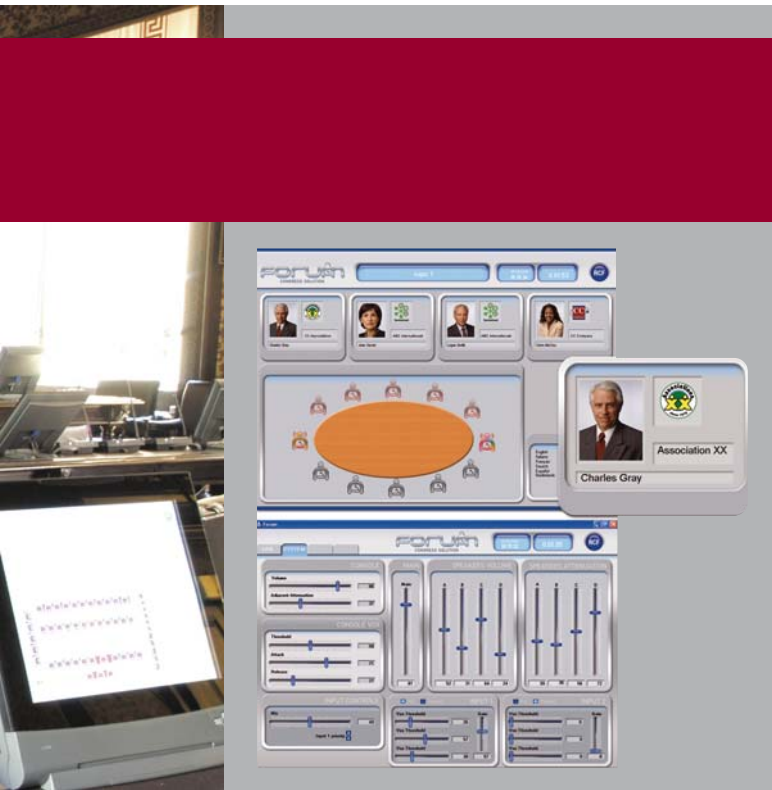

■ CAMERA CONTROL SOFTWARE FSW 9030 - D

(requires FSW9010-C)

p/n SW38003

This is a management software tool for interfacing and control Dome Cameras. It is used to recall preset positions previously memorized in the Dome Camera, according to the active microphone consoles. It requires the use of a Dome Camera which is controllable using the PELCO-D protocol, connected to the PC by a dedicated RS 485 serial connection. The software permits to drive the camera from the PC and to simply and quickly store the preset selections, directly clicking on the FSW 9010-C conference software synoptic screen.

Combined with the RCF audio/video matrix FVM 9844, the software FSW 9030-D is able to manage up to 4 FDC 9900 Dome Cameras, from the memorization of the presets into the Dome Camera to the Matrix management. It makes possible to obtain switching and smooth video transitions between the Dome Cameras, according to the microphone sets locations.

■ AUDIO RECORDING SOFTWARE FSW 9040 - R

(requires FSW9010-C)

p/n SW38004

This is used for the indexed audio recording of the speakers in digital format on the same PC used to manage the conference. The graphic interface is simple and intuitive. The audio files created have a standard ".wav" format (not compressed) and can be easily copied onto CD-ROM or any other storage support.

Each microphone intervention records the speaker data with time details including the duration of the intervention. The recordings can be replayed following each criterion or index by using the software FSW 9040-R.

The audio files can also be reproduced in sequence using a number of widely available software packages.

SYSTEM TECHNICAL OVERVIEW

The system is wired with reliable, convenient and easily available CAT5 UTP cables and RJ45 connectors. Boosters or splitters are not required: all the consoles can be connected to the 4 input lines of the Forum main unit, according to the hall architecture and the layout of the chairs.

Software diagnostic and some LEDs help the installer to control the system connections and its activation. The loudspeaker and headphone jack placed on the front panel of the main unit always allow to monitor the audio signal. **These features make the installation quick and easy.**

The software allows to number the connected consoles automatically, to recognize and select the console from its position in a univocal way (thanks to the LED close to the microphone end), to keep the management of each console and the entire configuration of the synoptic diagram as simple as possible. **The removal, the substitution and the addition of one or more consoles can be carried out without having to reconfigure the entire system.**

The system offers the possibility to assign various functions (chairman, secretary, delegated) to every microphone set in every moment, without modifying the system hardware. Every microphone unit can also be semi flush-mounted.



■ DOME CAMERA FDC 9900

p/n 171.80.003

Dome Camera with high speed movement. PAL system with PELCO D switching protocol. CCD 1/4" and 18X optical zoom.

- Sensitivity 0.01 Lux
- Resolution 752H X 582V
- Auto-focus, auto-iris, automatic white balancing
- Memorization of 128 preset
- Horizontal speed 0 - 300°/sec; vertical 0 - 120°/sec
- Power unit supplied
- Supplied with accessories for ceiling mounting, semi-flush or flush
- A/V streaming available

■ SWITCHING MATRIX FVM9844

p/n 171.80.012

Audio/video switching matrix with 4 inputs and 4 outputs with front panel or RS 232 serial controls (using FSW 9030-D software). It has a number visible indicators, auxiliary outputs for audio and video signal monitoring, BNC type video connections and RCA type audio connections.

- Power supply 230VAC
- 1U 19" rack



■ CABLE KIT FCAKIT - S p/n 171.80.004

Kit with 6 pieces CAT5E UTP cables 2.5 m each with RJ45 connectors and 2 pieces RJ45<->RJ45 joint. Grey cover.

■ CABLE KIT FCAKIT - L p/n 171.80.005

Kit with 6 pieces CAT5E UTP cables 10 m each with RJ45 connectors and 2 pieces RJ45<->RJ45 joint. Grey cover.

■ REEL FCA100 - BROWN p/n 171.80.008

Reel 100 m CAT5E FTP LSOH cable with dark brown RAL 8011 cover.

■ REEL FCA100 - BLACK p/n 171.80.007

Reel 100 m CAT5E FTP LSOH cable with black cover.

■ SMART CARD KIT FSC CARD p/n 171.80.006

Kit of 12 Smart Card (32 kbyte chip).

■ SMART CARD KIT FSC CARD p/n 171.80.006

Kit of 12 Smart-Card (32 kb chip). The cards are customizable with logos or text. It is possible to insert a magnetic strip in the cards for presence detector.



TRANSLATION SYSTEM | FORUM 2000



THE IDEAL SOLUTION FOR:
CONGRESS CENTRES
AUDITORIUMS
BOARD OF DIRECTORS MEETINGS
PARLIAMENTARY CHAMBERS
CONVENTIONS

SIMULTANEOUS TRANSLATION SYSTEM

With the FORUM 2000 simultaneous translation system RCF introduces not only a state of the art technology but also a new way to think, install, configure and use an interpretation system. In fact Forum 2000 uses a digital wireless ultra-high-frequency transmission with double encryption to always operate with maximum privacy and safety. The speech intelligibility and clarity are of the highest standards expected from a fully digital system. The RCF wireless technology utilizes a twin antenna (diversity) approach combined with an exclusive algorithm that guarantee a perfect coverage without shadow-areas and interference. All this is possible through a couple of discrete transmitting antennas which can be installed in a corner of the hall, connected to the transmitting unit which is the heart of the Forum 2000 system. The antennas are very compact and they can even be over-painted to perfectly match the decor of the hall. The radio transmission is not affected by bright ambient light conditions, offering always the maximum audio performance.

RCF Forum 2000 can be configured to manage up to 10 languages, 3 interpreters per booth and allows the operation of up to ten Forum 2000 independent systems in the same building location thanks to the 99 digital radio channels available. All wirings necessary to link the different hardwares are, following the RCF Forum philosophy, of simple CAT 5 UTP cable technology.



SPECIFICATIONS SIS 2411X

MAIN SUPPLY	70 Vdc THROUGH FMU 9100
ABSORPTION CURRENT	30 mA
AUDIO SPECIFICATIONS	
AUDIO OUTPUT POWER	0,5 W AT 16 Ohm (HEADPHONE) 1 W AT 8 Ohm (SPEAKER)
S/N RATIO	85 dB DIN AUDIO
FREQ. RESPONSE	20 - 13 kHz +/-1dB
MICROPHONE	REMOVABLE ELECTRET TYPE WITH DYNAMIC COMPRESSION
HEADPHONE OUTPUT	MONO 6,3 MM JACK AND 3,5 MM JACK
DISPLAY	DOUBLE DISPLAY, GRAPHIC WITH BACKLIGHT
□ MANAGED LANGUAGES	10
□ SIS 2411X PER BOOTH	3 (CONNECTED TO THE FMU 9100)
MAX CONNECTION DISTANCE	80 METER FROM THE FMU 9100

NOTE: FIRMWARE UP-GRADABLE FROM FMU 9100.



■ INTERPRETER CONSOLE TRANSLATOR SIS 2411 - X

p/n 171.80.017

The SIS 2411X interpreter set is intuitive to use and it has been designed into a strong metal die-cast construction, with detachable gooseneck microphone on XLR5 connector.

Wiring to FMU 9100 main unit is quick and simple through category 5 UTP cable and RJ45 connectors. Up to three SIS 2411X sets can be used in every interpreter booth.

The two LCD graphic displays respectively for input and output languages and the related encoder allow the quick configuration of input and output presets. The accurate construction permits semi-flush-mounting installation as well. SIS 2411X has a built in monitor speaker, double headphone connector (Jack 6,3 mm and jack 3,5 mm) and all controls and features required to meet the international standard ISO 2603.



■ INTERPRETER HEADPHONES SHI 2612

p/n 171.80.016

FORUM 2000 | RADIO TRANSMITTING UNIT



RADIO TRANSMITTING UNIT STU 2200

p/n 171.80.021

STU 2200 is the digital radio transmitting unit of the Forum 2000 system. It has to be connected to the system main unit FMU 9100, able to directly manage the Forum 9000 microphone sets or to interface any analogue system like RCF Forum 6000 or even a simple mixer-preamplifier, through one CAT 5 UTP cable.

STU 2200 sends "by UHF radio frequencies" the floor language and the translated languages with proper data encryption, in order to guarantee privacy and total safety.

It has a graphic display with related keys to simply select among the 99 available channels, in case two or more FORUM 2000 systems work together in close environments like a congress centre.

The STU 2200 has four built-in digital transmitter modules; one or two 3-channel extension kits STM

SPECIFICATIONS STU 2200

MAINS SUPPLY	230 / 115 Vac AUTO - CHANGE
POWER CONSUMPTION	150 W
RF CHARACTERISTICS	
OPERATING FREQ. RANGE	UHF: 800 TO 869,3 MHz
MAX NUMBER OF TX PER UNIT	10
RF OUTPUT	4
RF OUTPUT CONNECTOR	BNC
MAX NUMBER OF ANTENNA	4
DISTRIBUTION	1 ANTENNA EVERY 3 TX + 1 ANTENNA FOR FLOOR LANGUAGE
ANTENNA	YAGI 9 dB GAIN
TRANSMITTER TYPE	PLL SYNTHESIZER
RF OUTPUT POWER	+ 11 dBm +/- 1 dB ON 50 Ohm
CHANNEL PER TRANSMITTER	99
CHANNEL SPACING	700 kHz
TYPE OF TRANSMISSION	DIGITAL TYPE, RETURN TO ZERO
TYPE OF MODULATION	GMFSK BT 0.3
TRANSMISSION BIT RATE	96 kBit/s
STANDARD ELECTRICAL	ETSI 300 422
CHARACTERISTICS	
OUTPUT SIGNAL	DIGITAL AUDIO ENCRYPTED WITH TELEMETRY

NOTE: FIRMWARE UP-GRADABLE FROM PC THROUGH USB / SMART CARD FOR DATA LOADING / EASY CONNECTION TO THE CENTRAL UNIT FMU 9100 AS A STANDARD CONSOLE / TERMINATION IN CASE OF LAST UNIT OF A CASCADE CONSOLE.

2203 can be plugged-in to manage up to 10 channels if more languages are needed.

The transmitter has a USB port to allow an intuitive configuration through a PC.

High performance antennas are provided to easily and quickly cover an area of up to 6.000 to 10.000 sq. metres.



PORTABLE RECEIVER SDR 2599

p/n 171.80.023

The SDR 2599 receiver is a robust compact lightweight construction, intuitive to use and fitted with just the essential push-button commands for channel and volume selection.

The high contrast type display is visible in any light condition. When no signal is detected and the headphone is not connected the receiver is automatically switched off.

The audio quality always offers high voice intelligibility and the RCF digital UHF system guarantees noiseless reception without gaps. It is fitted with a Li-Ion rechargeable battery to avoid memory effect and increasing battery working life, thanks to the intelligent charger device built into the SRC 2756 case.



PAVILION HEADPHONES SPH 2605

p/n 171.80.035



SPECIFICATIONS SDR 2599

BATTERY TYPE	LITHIUM RECHARGEABLE
BATTERY CAPACITY	3,7 V TO 1.800 mA/h
AVERAGE AUTONOMY	UP TO 24 HOURS WHEN USED WITH 16 Ohm HEADPHONE
CHARGING TIME	MAX 6 HOURS
SWITCH ON SYSTEM	WITH KEY (TOGETHER WITH THE HEADPHONE CONNECTED)
SWITCH OFF SYSTEM	DISCONNECTION OF THE HEADPHONE
SWITCH OFF SYSTEM AUTOMATIC	ABSENCE OF TELEMETRY DATA OR IN CASE OF MINIMUM VOLTAGE
LEVEL INDICATION BATTERY	FLASHING RED LED (1 HOUR STILL)
DISPLAY	LED TYPE

RF CHARACTERISTICS

RECEIVER TYPE	SUPERETERODINA DOUBLE CONVERSION DIVERSITY
OPERATING FREQ. RANGE	UHF: 800 TO 869,3 MHz
CHANNEL FOR RECEIVER	99
CHANNEL SPACING	700 kHz
TYPE OF DE-MODULATION	DIGITAL GMFSK
AUDIO DECODER	DIGITAL SIGNAL PROCESSOR
SENSITIVITY	-98 dBm
ANTENNA	2 INTERNAL, DIVERSITY

AUDIO SPECIFICATIONS

MODE	MONO
AUDIO OUTPUT POWER	0,5 W AT 16 Ohm (DIGITAL AMPLIFIER)
S/N RATIO	80 dB DIN AUDIO
FREQ. RESPONSE	20 TO 5.500 Hz +/-1dB
CONNECTOR	JACK 3,5 MM

NOTE: FIRMWARE UP-GRADABLE FROM PC THROUGH USB WHEN THE RECEIVER IS PLACED IN THE RECHARGING CASE / FACTORY DEFAULT CONFIGURATION DOWNLOAD FROM THE RECHARGING CASE / REAL TIME ALGORITHM ERROR CORRECTION.

The receiver is able to detect up to 99 different channels in case more Forum 2000 systems need to work together in the same environment at the same time. The double encrypting facility is guaranteed by using a programmable pod included in the case SRC 2756.



SPECIFICATIONS SAI 2855

MAIN SUPPLY	70 Vdc
POWER CONSUMPTION	7 W
AUDIO SPECIFICATIONS	
AUDIO INPUTS BALANCED	5, XLR CONNECTOR, VARIABLE GAIN
AUDIO INPUTS UN-BALANCED	5, RCA WITH VARIABLE GAIN
AUDIO OUTPUTS BALANCED	5, XLR WITH VARIABLE VOLUME
AUDIO OUTPUTS UN-BALANCED	5, RCA WITH VARIABLE VOLUME
INPUT LEVEL	3 V MAX
INPUT GAIN	40 dB VARIABLE
INPUT INPEDANCE	10 kOhm
OUTPUT LEVEL	3 V
OUTPUT IMPEDANCE	600 Ohm
S/N RATIO	85 dB DIN AUDIO
FREQ. RESPONSE	20 - 13 kHz +/-1dB

NOTE: FIRMWARE UP-GRADABLE FROM USB INTERFACE / MUTING PULSE PER INPUTS/OUTPUTS / PRESET MUTING SELECTABLE WITH KEY / LINK BETWEEN FMU 9100 AND INTERPRETER CONSOLES.

ANALOG INTERFACE SAI 2855

p/n. 171.80.022

SAI 2855 is a rack unit interface able to manage 5 analogue inputs and 5 analogue outputs to and from the language channels digital system bus.

It is equipped with XLR and RCA connectors to permit the recording of 5 translated languages and to send 5 audio channels into 5 slots of the simultaneous translation system; this is important, for instance, when

is needed to send to the delegates (having SDR 2599 wireless receivers or the Forum 9000 series FMS 9411 microphone consoles) pre-translated contributions alternative to the ones processed by the interpreters. LED signal indicators and mute buttons are available on each channel. A smart pre-set facility to "ON" and "OFF" group of channels is available too.

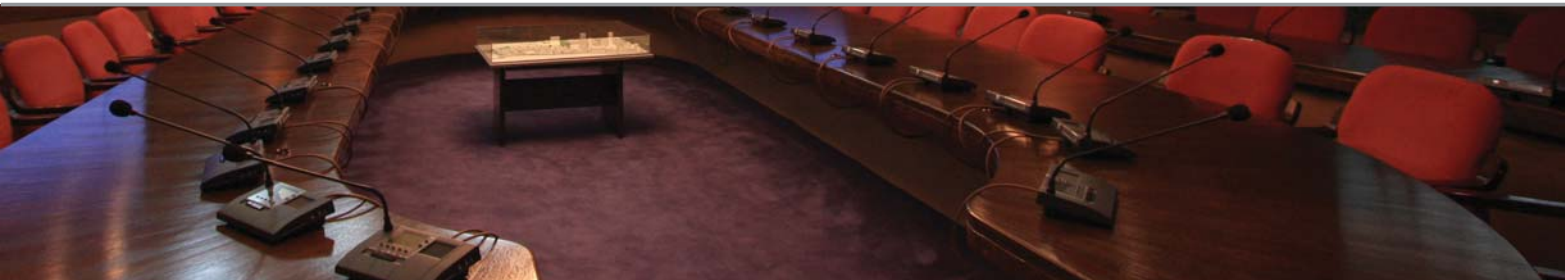



SPECIFICATIONS SRC 2756

MAINS SUPPLY	110 / 240 AUTOMATIC
POWER CONSUMPTION	150 W

GENERAL SPECIFICATIONS

MAX NUMBER OF RX PER CASE	56 RECEIVERS SDR 2599
PROGRAM/ENCRYPTING INTERFACE	USB
CHARGING TIME	MAX 6 HOURS
CHARGING CURRENT	480 mA MAX
CHARGER TYPE	CONSTANT VOLTAGE AND CURRENT
CHARGING INDICATIONS	LEDS ON EACH RECEIVER
CHARGING PROCESS	INDEPENDENT PER EACH RX

NOTE: DISPLAY AND USB INTERFACE FOR FIRMWARE UPGRADE AND ENCRYPTION / ENCRYPTING PRESETS AVAILABLE IN THE CASE / RESET OF ALL RECEIVERS STORED IN THE CASE.

RECHARGING CASE SRC 2756

p/n 171.80.018

The SRC 2756 is a strong and practical recharging and transport case, allowing the smart charging of 56 receivers and the programmability/ implementation of the double encrypting facility through a dedicated POD present inside the case.

Recharging process is independent for each receiver and it is conveniently indicated. A dedicated USB connection is available to upload the unique code. The SRC 2756 has a main socket to link a second case and the charging can be done with the cover positioned.



CONFERENCE SYSTEM | FORUM 6000



THE IDEAL SOLUTION FOR:
 COUNCIL CHAMBERS
 CONGRESS CENTRES
 BOARD OF DIRECTORS MEETINGS
 (BANKS, INSURANCE FIRMS, ETC.)
 LAW COURTS
 AUDITORIUMS



DIGITAL CONFERENCE AND DISCUSSION SYSTEM

The RCF Forum 6000 system has been designed to manage conference, debates, president desks in auditorium/conventions and meetings, offering outstanding versatility.

The system is simple and quick to wire, to set up and to use. It is possible to connect to the main system unit up to 60 microphone set on two different lines. Several operational modes can be chosen through the LCD display and simple menus. For more advanced use a complete set up menu adds flexibility to the system allowing you to personalize several parameters. Thanks to the DEC 6104 expander board and the DPS 6202 additional power supply is possible to connect up to 120 additional consoles on four connection lines. Forum 6000 system is designed according to IEC 60914 standard.

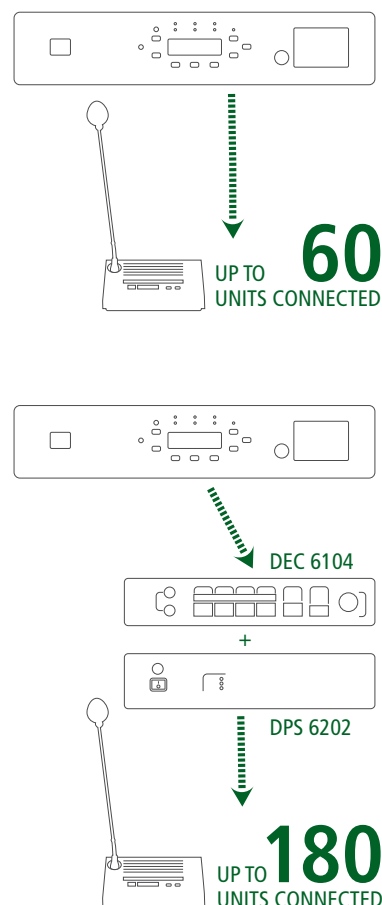



THE 6000 SYSTEM

- Free Discussion (where all microphones can be activated at the same time)
- Discussion with limited number of active microphones (6 to 1)
- Discussion with one microphone active at a time with override facility of the previous one
- Simultaneous or sequential guest-language interpretation system
- Booking facility can be associated to the discussion modes and queue size can be limited from 10 to 1. When the number of open microphones (NOM) has been reached, next consoles booked will be automatically switched-on according to the list as soon as someone "cuts-out" his microphone
- Automatic microphone switch-off after 30 seconds of inactivity can be introduced
- Configuration of the 2 universal aux inputs in combination with Vox, activation/mute command and priority setting
- PC control interface based on synoptic view and dome camera control (DEC 6140 expander board required)
- A/V streaming
- It is also possible to transmit the video, the synoptic view and the voting results on a LCD, plasma or video projector

EASY TO INSTALL

Two lines of 30 microphone consoles each can be linked to the main unit, just in a daisy chain mode. A software option helps the installer to know in detail the system configuration and possible connection faults through the main unit display. Consoles can be desk top or semi-flush mounted. RJ connectors and a special thin multi cable make the installation wiring extremely quick and simple. One console is usable as desk-top or semi-flush mounting, in 3 configurations: Chairman (max 3 president consoles can be configured for each system); Delegate; Interpreter (2 interpreter consoles can be configured).

EASY TO USE AND EASY TO MOVE

Display and clear commands make the RCF Forum Discussion System simple also for non-familiar new users. The microphone console is compact and has an optimized weight to be "solid" but not over heavy to limit the portability.

EASY TO MANAGE

Several operational modes are available to meet any conference requirements. During operation it is possible to change the operation mode without interrupting the session. For instance when passing from free-discussion to a certain Number Open Microphones the system allows the microphone to be switched "OFF" but not "ON" until the correct number has been reached.

EASY TO MANAGE AN ALTERNATIVE LANGUAGE GUEST

A simultaneous or sequential interpretation system helps to manage a bilingual conference, a second language relator or other language guest. The two 3,5mm jack available on the sides of the console can be also used as recording outputs leaving the built-in speaker working even when jack is inserted: typical application is a remote/local recording during a press-conference through the headphone outputs.

FORUM 6000 | CENTRAL UNIT



CENTRAL UNIT DMU 6100

p/n 171.80.010

The DMU 6100 is the heart of the system allowing the direct connection of up to 60 microphone sets on two lines. The status is available on the LCD, including advice of the type of consoles connected. Two universal inputs are also available for connecting any additional sources such as a wireless microphone or a lectern microphone or any other complementary device, even a mixer-preamplifier. These two inputs can be configured in different ways; for instance they can be mixed with the microphones sets, have priority on them, one input mixed and one with priority etc. VOX operation mode or command operation mode are available to increase flexibility.

REC-PLAY input and outputs associated to a switch allow the connection of any recorder/player. Dedicated IN and OUT audio connections are available for linking DMU 6100 to a teleconference system. 4 additional Auxiliary Outputs are available for the independent recording of the 2 universal inputs and each of the 2 lines of microphone sets, this helps in systems where verbalization/recording must be done separately like law-courts. From the front panel of the main unit LCD, function buttons and LEDs help the installer and the user in adjusting all the parameters and volumes, while a speaker and a 1/4" jack work as audio monitoring.



SPECIFICATIONS DMU 6100

MAINS	100 □ 240 Vac (50 - 60 HZ)
MAINS - MAX CURRENT	1,7 A (230 V) / 3,5 A (115 V)
MAX POWER CONSUMPTION	200 W
OPERATING TEMPERATURE	0 □ 50 □C / 32 □ 122 □F
DIMENSIONS (W X H X D)	430 X 88 X 310 MM
WEIGHT (NET)	5,6 Kg

MIC / LINE INPUTS

FREQ. RESPONSE (-3 dB)	50 Hz □ 20 kHz (TO MAIN OUT)
HIGH-PASS FILTER	12 dB / OCT (- 3 dB AT 100 Hz)
S/N RATIO	≥ 65 dBA (MIC) / ≥ 85 dBA (LINE)

PLAY INPUT

FREQ. RESPONSE (-3 dB)	50 Hz □ 20 kHz (TO MAIN OUT)
S/N RATIO	≥ 85 dBA

MAIN OUT

OUTPUT LEVEL NOMINAL	0 dBu (THD <0.1%); MAX +20 dBu (THD 0.5%)
PRESENCE CONTROL	MAX + 15 dB AT 2.1 kHz

SYSTEM REC OUTPUT

FREQ. RESPONSE (-3 dB)	35 Hz □ 20 kHz
S/N RATIO	≥ 85 dBA



FORUM | CONSOLE 6000



CONSOLE DMS 6410

p/n 171.80.011

One type of console is available; through DIP switches you can configure it as Chairman, Delegate or Interpreter. The RCF Forum 6000 System has an integrated guest-language interpretation facility, simultaneous or sequential. The listening to the translated language is achieved using the headphone sockets available on each microphone set and its built-in gooseneck microphone. The consoles configured as an interpreter can be one or two, linked to the dedicated RJ connectors available on the main unit DMU 6100. Speak slowly command is available and lights-up an LED on the active microphone set. When configured as "Delegate Console" the DMS 6410 has a microphone button and mute facility, in "Chairman Mode" the system offers talk and priority buttons that, if pushed together cancel the active microphones with re-set purpose. Delegate and Chairman talk buttons are smart buttons working both as PTT or PTL (push to lock) according respectively to a long or short pressure of the buttons. On the president console

SPECIFICATIONS DMS 6410 / DMS 6410 - X

MICROPHONE TYPE	ELECTRET, HYPER-CARDIOID
FREQ. RESPONSE (-3 dB)	200 Hz □ 12 kHz
S/N RATIO	≥ 60 dBA (TO MAIN OUT)
INTERNAL LIMITER	UP TO + 32 dB OVER 100% LEVEL
MIC AUTO-OFF SIGNAL THRESHOLD	- 20 dB
DIMENSIONS (W X H X D)	200 X 135 X 60 MM (EXCLUDING GOOSENECK MICROPHONE)
WEIGHT	1,1 Kg
GOOSENECK MIC. LENGTH	450 MM
CABLE/ CONNECTORS	RCF MODEL DCA 6000/RJ45 10 P, 2.5 M CONNECTION CABLE PROVIDED
JACK OUTPUTS	
MAX POWER (HEADPHONES MODE)	60 MW ON 16 Ohm (<0.5% THD)
OUTPUT LEVEL (RECORDING MODE)	NOMINAL: - 4 dBu (0.2% THD), MAX. + 5 dBu
FREQ.RESPONSE (-3 dB)	125 Hz □ 16 kHz

NOTE: POSSIBILITY TO FIX THE MICROPHONE SET TO THE DESK /SEMI FLUSH MOUNTING.
60 CM GOOSENECK MICROPHONE AVAILABLE

a chime-tone can be associated to the priority button; the chime sound can be also activated through an external command linked to the terminals available on the rear panel of the DMU 6100 master unit. **Audio quality is assured by a professional gooseneck hyper-cardioid microphone** that, according to the version is screwed directly into the base (fixed installations version) or plugged through an XLR connector (rental/portable version model DMS 6410X) and a high efficiency full-range speaker with neodymium magnet. Volume control is adjusted by push-buttons. The console has been designed to be semi flush-mounted in order to have a discrete visual impact when installed in particular environments. The signal of the microphone is not affected by mobile phones transmissions.



CONSOLE DMS 6410 - X

p/n 171.80.013

REMOVABLE GOOSENECK

FORUM 6000 | EXPANDER BOARD



EXPANDER BOARD DEC 6104

p/n 171.80.010

The DEC 6104 Expander Board is to be installed in the slot available on the rear panel of the DMU 6100 main unit of the RCF FORUM 6000 conference system and adds important additional features to the system configuration and operation.

This new board provides a USB port and a RS 485 port (alternative) to connect the system to a PC, allowing the remote control through a synoptic application control software (provided), and it adds a simpler and intuitive system configuration tool, with audio recording possibility.

The DEC 6104 is equipped with a dome camera automatic control facility through the connected PC. Up to 4 dome cameras FDC 9900 (p/n 17180003) and the audio/video matrix FVM 9844 (p/n 17180012) can be interfaced to always get the speaker tracked. The cameras and matrix set-up are integrated into the provided PC software.

The DEC 6104 built in digital processor (DSP) presents an exclusive algorithm and an interactive functionality with the FORUM 6000 (filters are dynamically driven/triggered by the system working/operation mode) that limit the acoustic feedbacks due to

loudspeakers too close to microphone consoles, loudspeaker's at high volume or when there are several open microphones at the same time.

The DEC 6104 allows to connect 120 additional system microphone consoles DMS 6410 and/or DMS 6410X to the system on its 4 ports (30 consoles each). Whenever this feature is used, the additional power supply unit DPS 6202 is required.

In this way FORUM 6000 can reach up to 180 fully managed microphone sets.

- Up to 180 DMS 6410 microphone consoles on 6 lines (4 line outputs are on the DEC 6104 board)
- The further 120 consoles shall be powered by the DPS 6202 power supply unit
- USB port to connect the system to a PC
- FORUM 6000 control software included
- RS 485 port (alternative to the USB port) for long distance control (up to 1.2 km) of the system through the PC software
- Anti-feedback processor, useful to avoid feedbacks due to loudspeakers too close to microphones, loudspeaker high volume and many open microphones at the same time.

FORUM 6000 | ADDITIONAL POWER SUPPLY UNIT MICROPHONE TRANSPORT CASE



■ ADDITIONAL POWER SUPPLY UNIT DPS 6202

p/n 171.80.033

The DPS 6202 power supply unit is strictly necessary for the console lines 3, 4, 5 and 6 placed on the DEC 6104 board to power consoles from the 61 to 180.

- Dual switching power supply
- Main switch with ON LED indicator on front panel
- LINE LEDs indicate when console lines are correctly powered
- Power output on 7-pin XLR connector (connection cable to DEC 6104 provided)

■ DMS 6410X MICROPHONE TRANSPORT CASE DCT 6012

p/n 171.80.037

The DCT 6012 Transport Case for 12 DMS 6410X Microphone Consoles is the perfect to storage and transport the Forum 6000 system.

- 12 DMS 6410X microphone consoles can be stored in the case
- Aluminum hi-composite construction with rugged chromium-plated metal reinforced angles
- Separated microphone and cables compartments
- Soft inner protections against shocks for a safer transport
- Comfortable top handle



FORUM 9000

MID-SIZE FORUM 9000 AND FORUM 2000 CONFERENCE SYSTEM

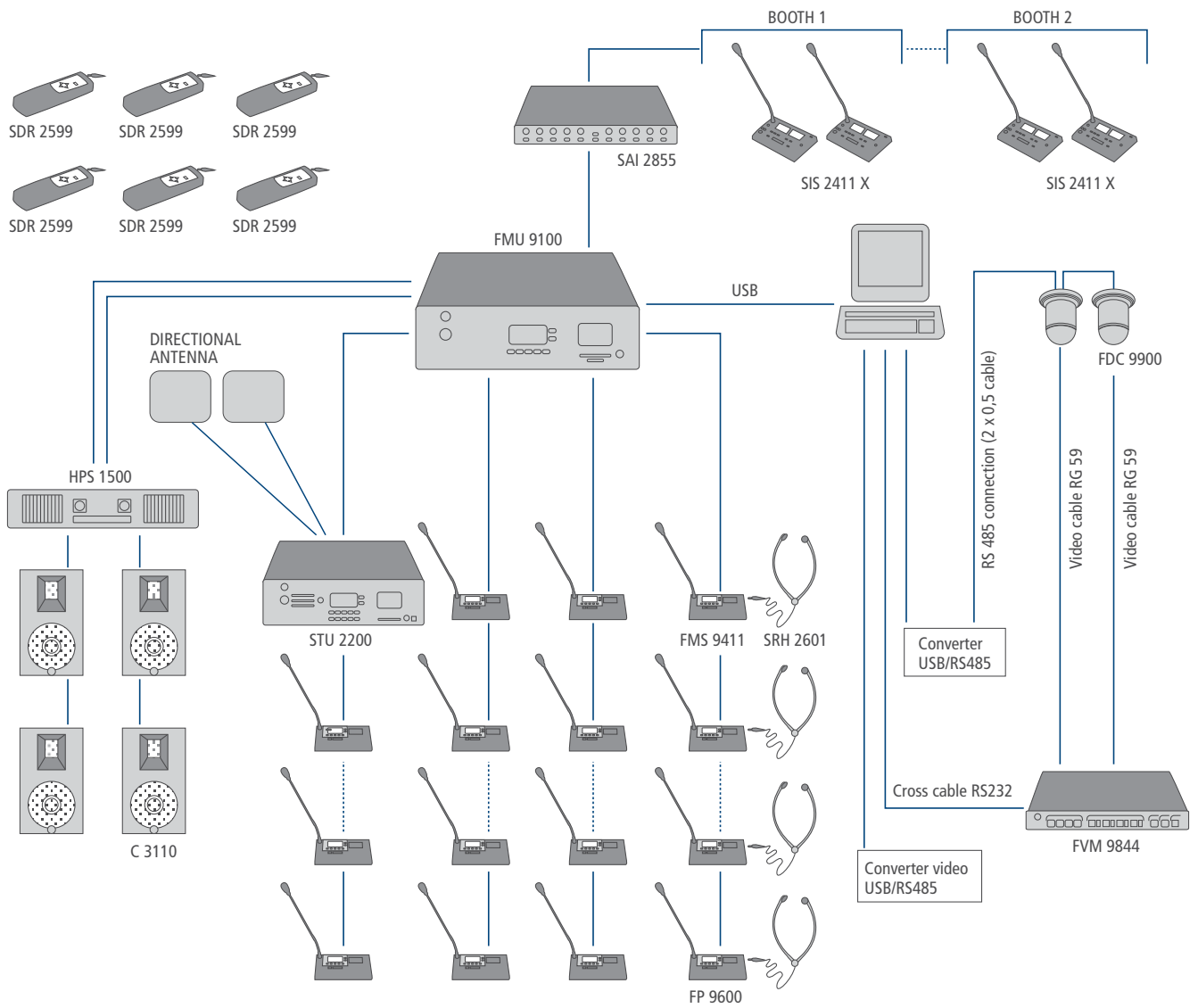

FORUM 9000

LARGE SIZE FORUM 9000 AND FORUM 2000 CONFERENCE SYSTEM

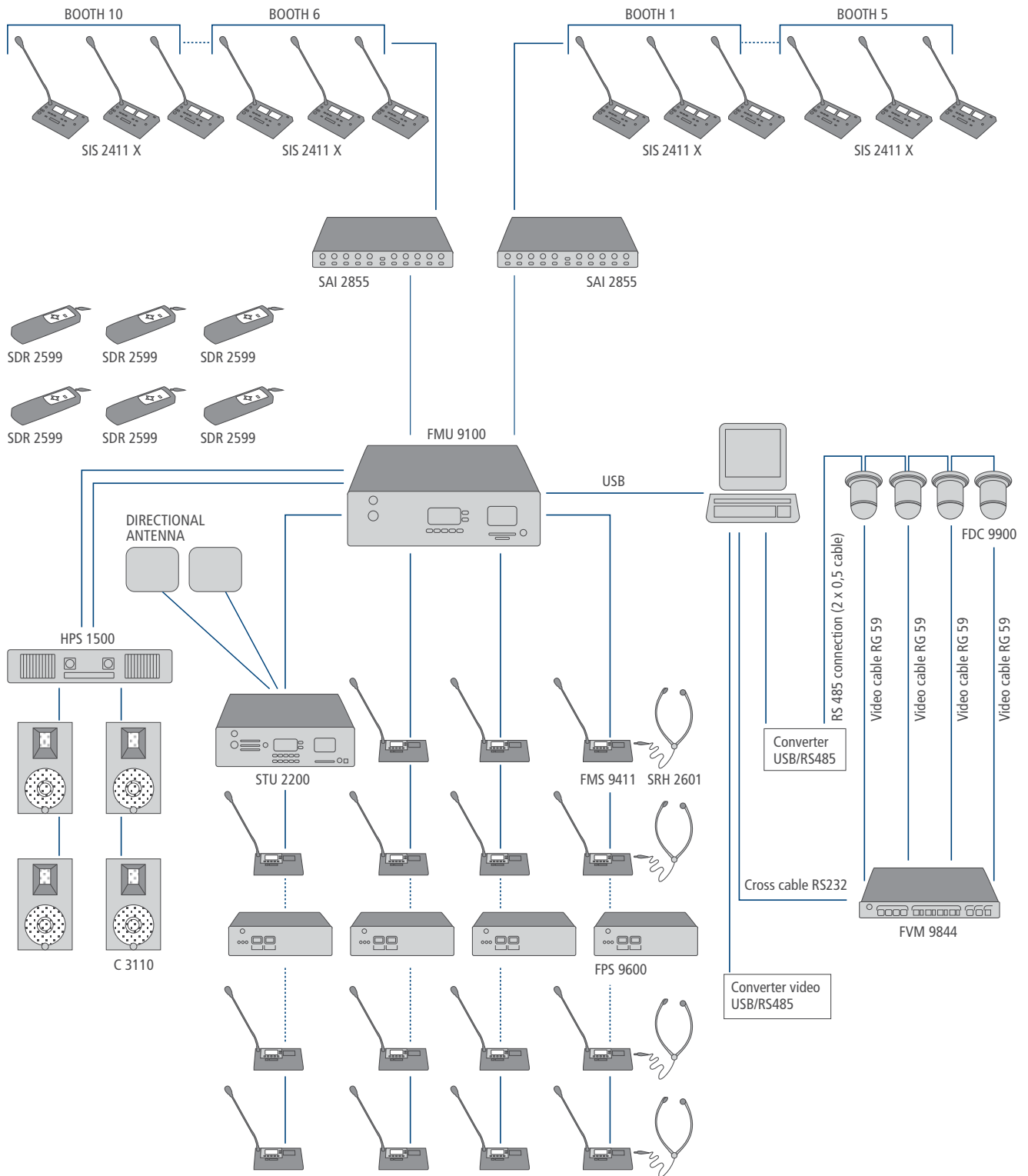

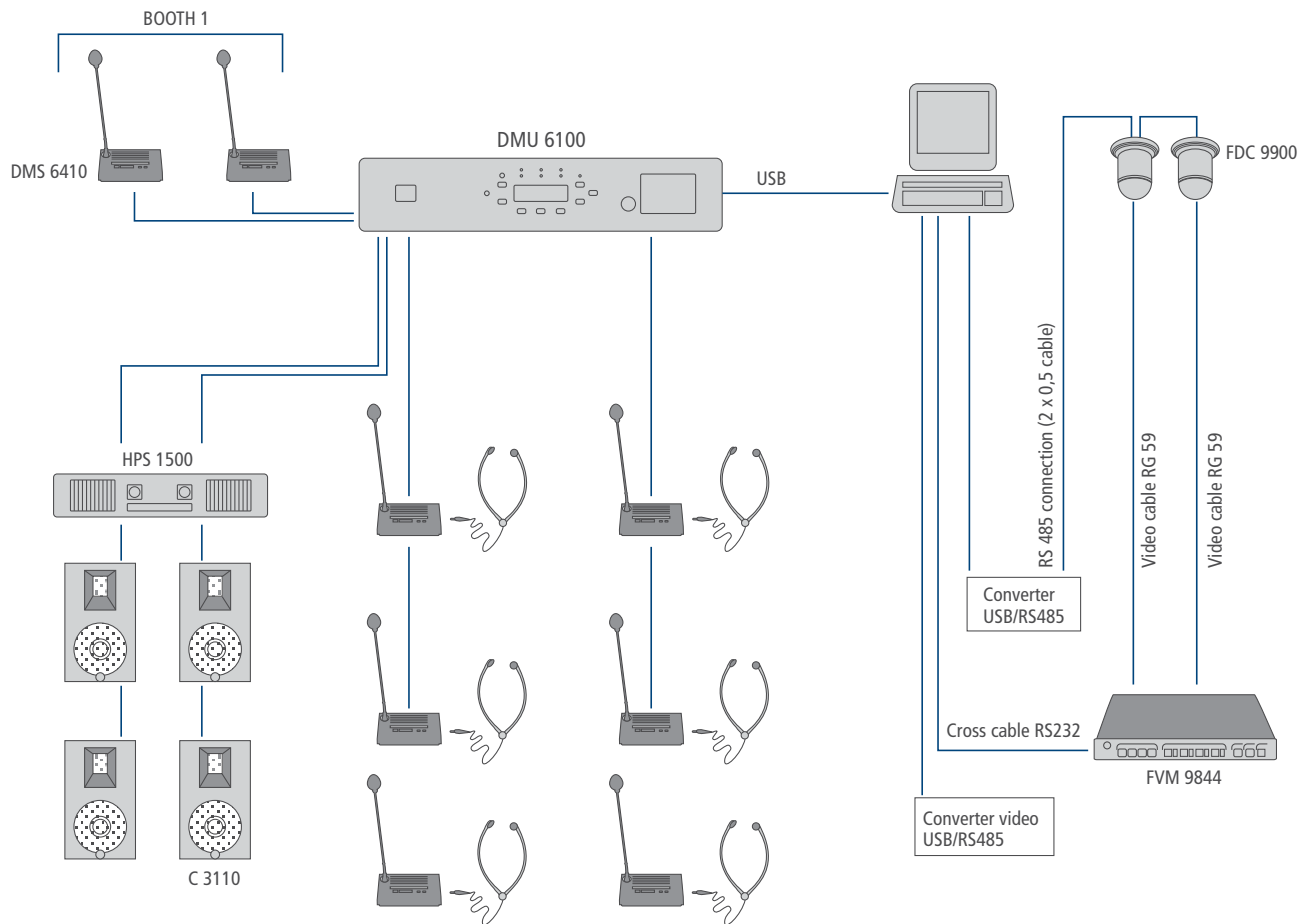

FORUM 2000

FORUM 6000 AND FORUM 2000 CONFERENCE SYSTEM

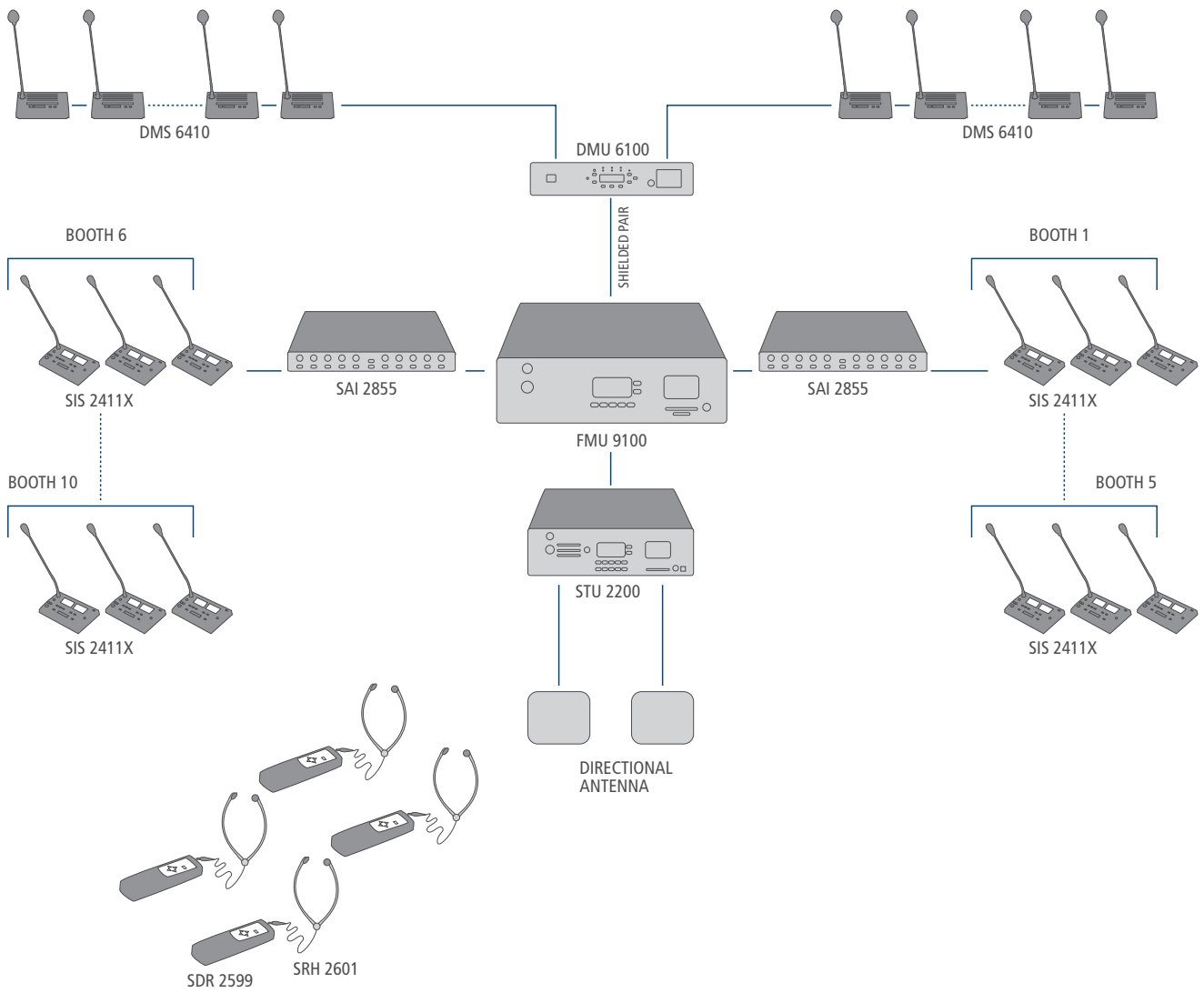

RCF congress systems are used the world over for their efficiency and usability. This is just a selection of recent projects realized with our systems.

Dushambe Palace of Nations (Tajikistan)

[Lincoln Council Chamber \(UK\)](#)

Equatorial Guinea Parliament

[Cardiff Council Chamber \(UK\)](#)

Costantine Council Chamber (Algeria)

[Kish Island Congress Centre \(Iran\)](#)

Salon de Plenos del Ayuntamiento de Calzada de Calatrava (Spain)

[Basingtoke and Deane Civic Offices \(UK\)](#)

Guangzhou Nansha Port Container Terminal Co., Ltd (China)

[Ministry of the Interior, Rome \(Italy\)](#)

Assemble City of Trebinje (Serbia)

[Sarajevo Council Chamber \(Bosnia-Erzegovina\)](#)

Supreme Court of Appeal, Rome (Italy)

[Naples Town Hall \(Italy\)](#)

Dongguann Service Center For Labor And Employment, (China)

[Beijing Tumor Hospital Multifunctional Hall \(China\)](#)

Mantova Council Chamber (Italy)

[Piombino Council Chamber \(Italy\)](#)

Fermo Council Chamber (Italy)

[Tortona Council Chamber \(Italy\)](#)

Sala delle Tarsie Provincia di Vercelli (Italy)

[Parma Town Hall \(Italy\)](#)

Lecce University (Italy)

[Catanzaro Town Hall \(Italy\)](#)

Trapani Town Hall (Italy)

[Circoscrizioni Comunali of Turin \(Italy\)](#)

Stella Maris Tirrenia Foundation (Italy)

[Sala dell'Alto Comando del Mediterraneo, Genova Port Authorities \(Italy\)](#)

Bra Council Chamber (Italy)

University of Electronic Science and Technology of China Zhongshan Institute

Bania Luka Council Chamber (Bosnia-Erzegovina)

